

CLAY FACE BRICK
Special Shapes



CLAY FACE BRICK RANGE

Special Shaped Bricks

■ Denotes normally exposed face

Stock Special Shape Bricks

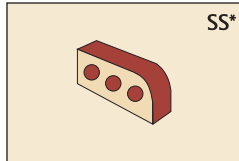

Single Bullnose

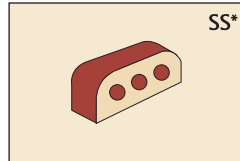

Double Bullnose

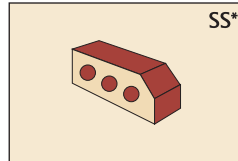

Single Cant

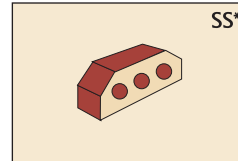

Double Cant

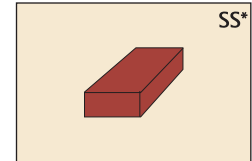

Solid

Made to Order

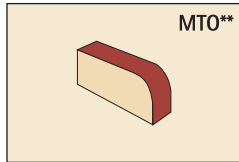

Single Bullnose Solid

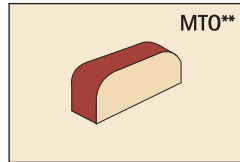

Double Bullnose Solid

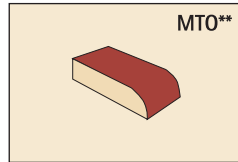

Bullnose Header
on Flat

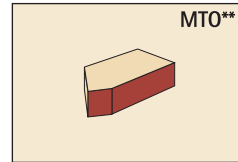

Squint 30°/45°/60°

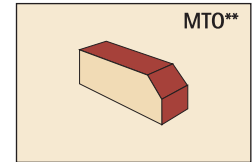

Single Cant Solid

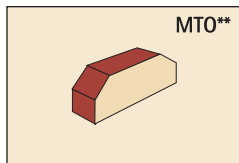

Double Cant Solid

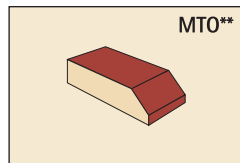

Plinth Header Solid

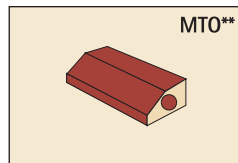

Plinth Stretcher

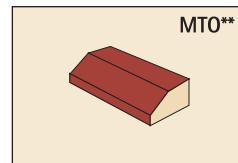

Plinth Stretcher Solid

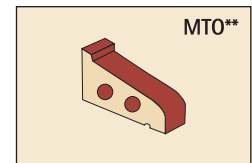

Sill Brick I

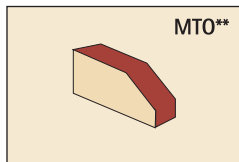

Sill Brick II

Purpose Made Specials

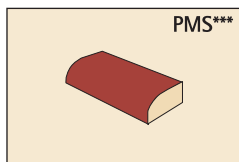

Bullnose Stretcher
on Flat

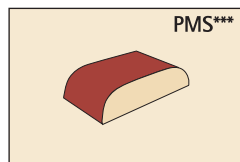

Bullnose Double
Header on Flat

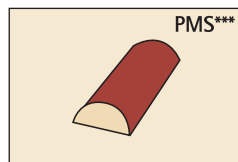

Bullnose Double
Stretcher on Flat

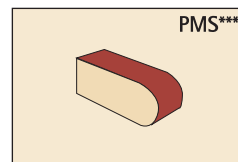

Bullnose on End
(Cownose)

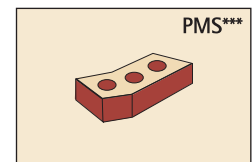

External Angle 45°

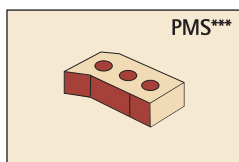

Internal Angle 45°

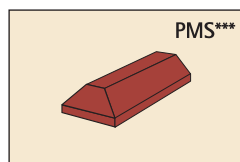

Plinth External
Return

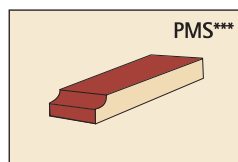

Concave Header

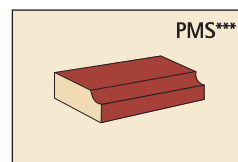

Concave Stretcher

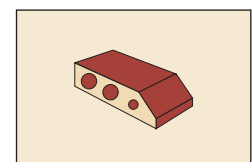

Plinth Header

CLAY FACE BRICK

Dimensions

Single Bullnose

- A 222mm
- B 106mm
- C 73mm
- R 53mm

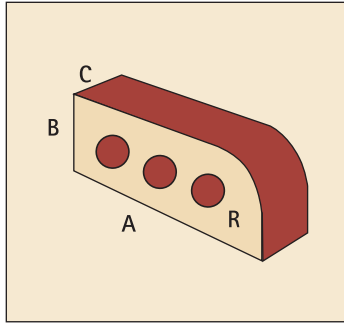

Single Bullnose Solid

- A 222mm
- B 106mm
- C 73mm
- R 53mm

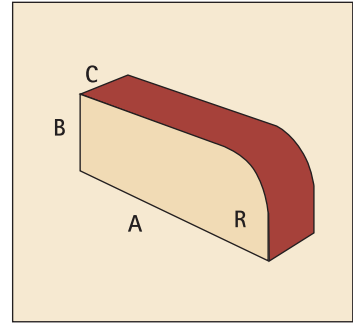

Double Bullnose

- A 222mm
- B 106mm
- C 73mm
- R 53mm

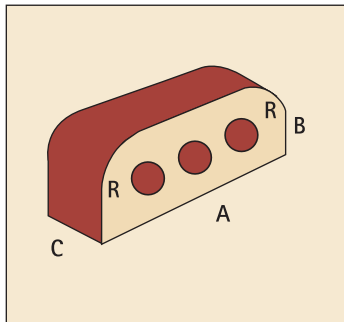

Double Bullnose Solid

- A 222mm
- B 106mm
- C 73mm
- R 53mm

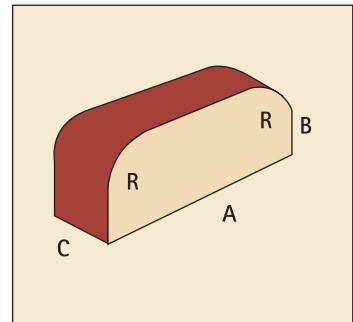

Bullnose Header on Flat

- A 222mm
- B 106mm
- C 73mm
- R 53mm

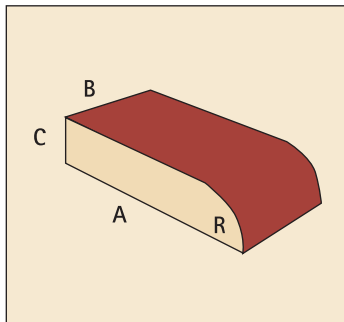

Bullnose Stretcher on Flat

- A 222mm
- B 106mm
- C 73mm
- R 53mm

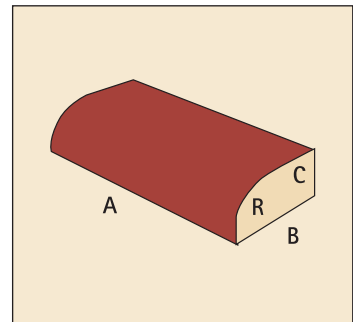

Bullnose Double Header on Flat

- A 222mm
- B 106mm
- C 73mm
- R 53mm

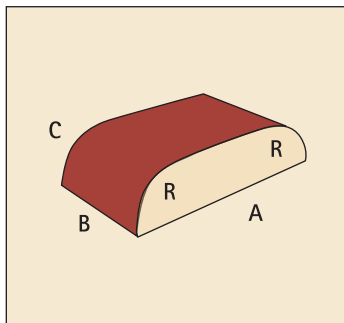

Bullnose Double Stretcher on Flat

- A 222mm
- B 106mm
- C 73mm
- R 53mm

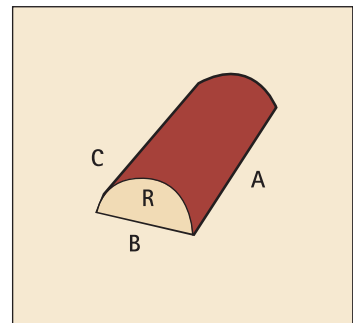

Bullnose on End (Cownose)

- A 222mm
- B 106mm
- C 73mm
- R 53mm

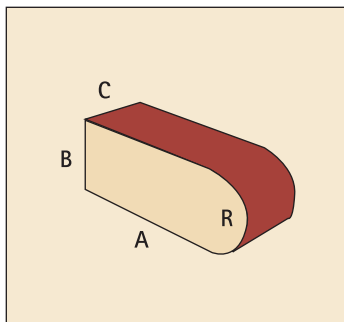

Squint

- | | 30° | 45° | 60° |
|---|-------|-------|-------|
| A | 169mm | 169mm | 169mm |
| B | 106mm | 106mm | 106mm |
| C | 73mm | 73mm | 73mm |
| D | 53mm | 53mm | 53mm |
| E | 169mm | 138mm | 92mm |
| F | 92mm | 97mm | 120mm |

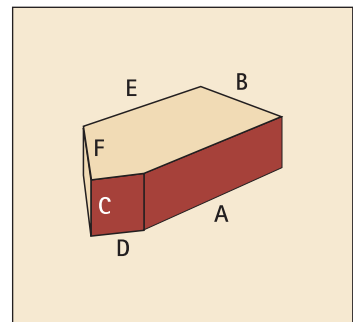

CLAY FACE BRICK

Dimensions

External Angle 45°

- A 222mm
- B 106mm
- C 73mm
- D 106mm
- E 178mm
- F 57mm

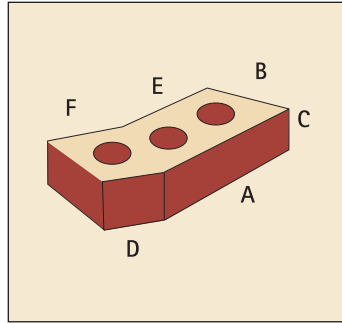

Internal Angle 45°

- A 130mm
- B 106mm
- C 73mm
- D 13mm
- E 174mm
- F 57mm

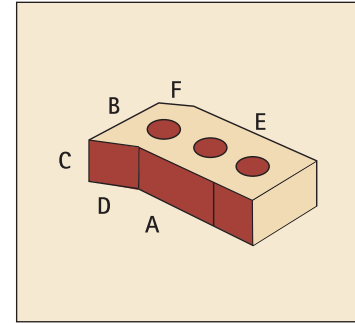

Single Cant

- A 222mm
- B 106mm
- C 73mm
- D 48mm
- E 164mm

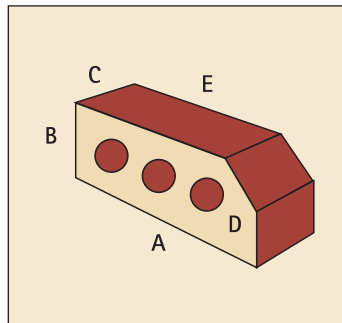

Single Cant Solid

- A 222mm
- B 106mm
- C 73mm
- D 48mm
- E 164mm

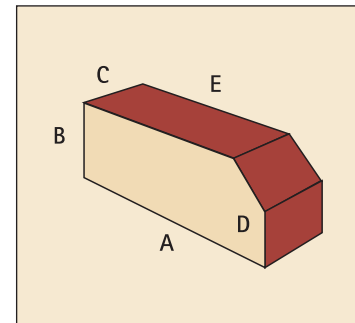

Double Cant

- A 222mm
- B 106mm
- C 73mm
- D 48mm
- E 106mm

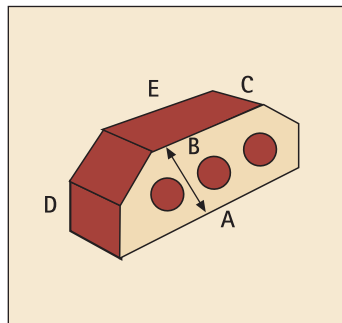

Double Cant Solid

- A 222mm
- B 106mm
- C 73mm
- D 48mm
- E 106mm

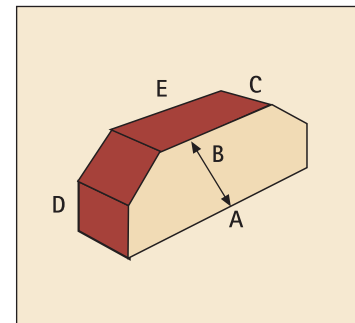

Plinth Header

- A 222mm
- B 106mm
- C 73mm
- D 15mm
- E 164mm

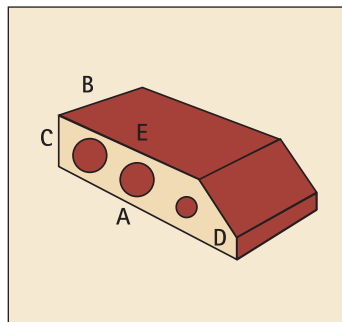

Plinth Header Solid

- A 222mm
- B 106mm
- C 73mm
- D 15mm
- E 164mm

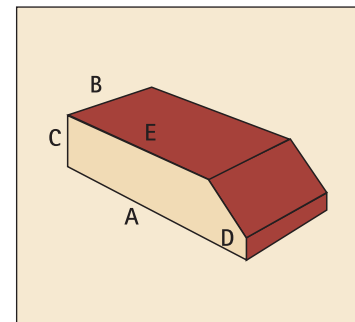

Plinth Stretcher

- A 222mm
- B 106mm
- C 73mm
- D 15mm
- E 48mm

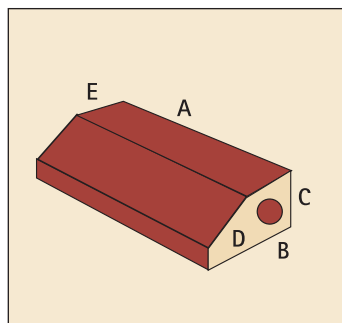

Plinth Stretcher Solid

- A 222mm
- B 106mm
- C 73mm
- D 15mm
- E 48mm

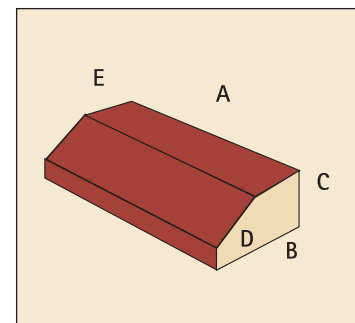

CLAY FACE BRICK

Dimensions

Plinth External Return

- A 222mm
- B 106mm
- C 73mm
- D 15mm
- E 164mm
- F 48mm

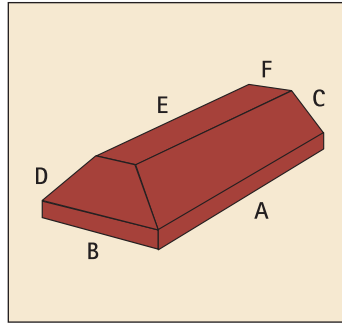

Concave Header

- A 48mm
- B 222mm
- C 73mm
- R 25mm

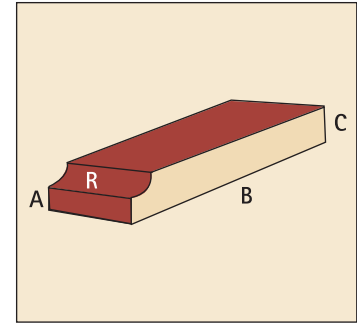

Concave Stretcher

- A 106mm
- B 222mm
- C 73mm
- R 25mm

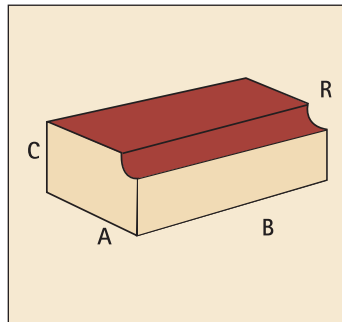

Sill Brick I

- A 222mm
- B 106mm
- C 73mm
- D 10mm
- E 25mm
- R 50mm

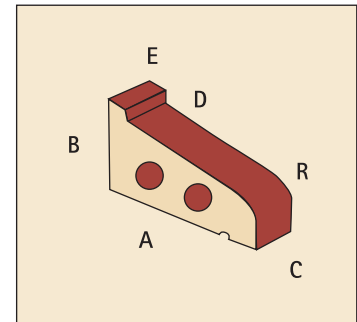

Solid

- A 73mm
- B 106mm
- C 222mm

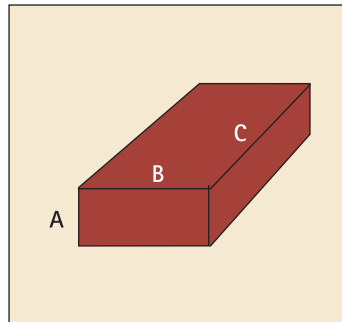

Sill Brick II

- A 222mm
- B 106mm
- C 73mm
- D 53mm
- E 111mm

